

IN2GLASS the perfect shading solution

IN2GLASS
INSULATED GLASS BLINDS

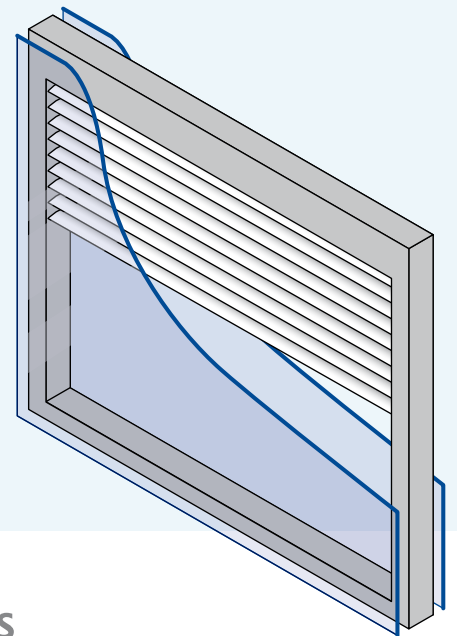

IN2GLASS, blinds for insulated glass units

IN2GLASS Blinds are the perfect glazing partner for residential, medical, educational and commercial buildings; sealed from any ingress of dust or moisture and protected from misuse they provide a unique solution for enhanced privacy and a reduction in sound and solar glare. IN2GLASS blinds will improve the acoustics of most interior spaces by providing an effective barrier to sound penetration while at the same time allowing partial or complete privacy. For the designer, blinds are both a creative and practical solution adding elegance and style while at the same time offering a safe and low maintenance answer to providing an effective control of light, heat and privacy.

IN2GLASS Blinds are available in aluminium & in Pleated and/or Duette fabrics, made to the measure in a choice of designs & colours.

IN2GLASS, systems & options

Aluminium blind

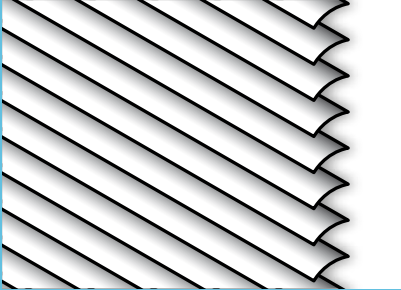

Pleated

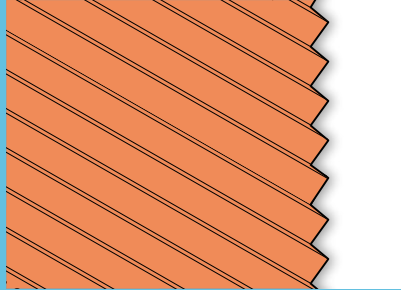

Duette

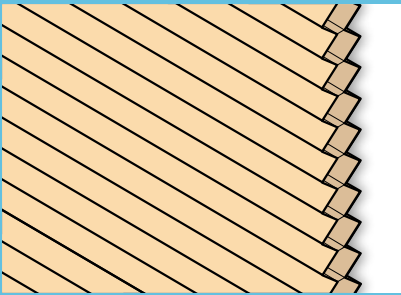

Combi Pleated & Duette

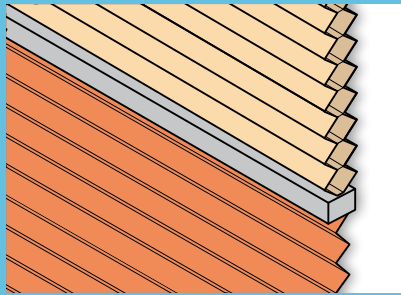

Tilt and lift

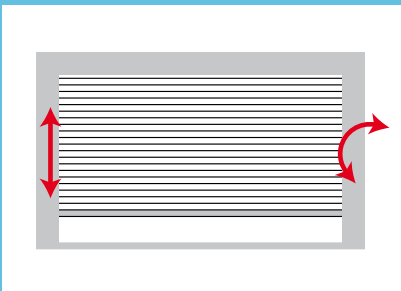

Only tilt

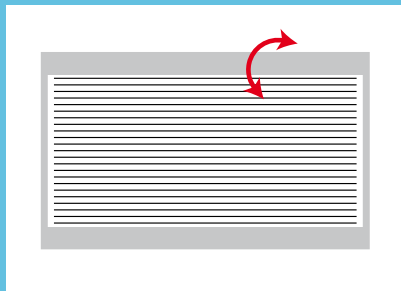

Electric

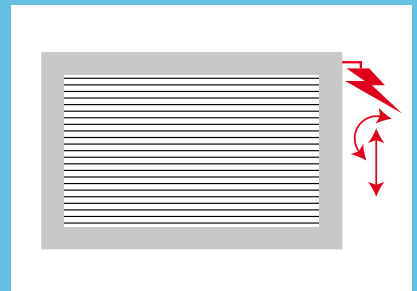

Description	Cavity excl. glass				Tilt & Lift	Lift only	Tilt only	Dimensions in mm*	
	18mm	20mm	25mm	27mm				Width	Height
Aluminium 12.5 mm	v	v	v		v	v	v	300 - 2000	500 - 2200
Aluminium 16 mm			v		v	v	v	300 - 2000	500 - 2200
Aluminium electric				v	v			650 - 2000	500 - 2200
Pleated 20 mm			v			v		600 - 1400	600 - 2000
Duette 20 mm			v			v		600 - 1400	600 - 2000
Combi pleated - duette			v			v		600 - 1400	600 - 2000
Pleated electric				v		v		600 - 1400	600 - 2000
Duette electric				v		v		600 - 1400	600 - 2000
Combi electric				v		v		600 - 1400	600 - 2000

* based on 4mm glass thickness



Applications

IN2GLASS Blinds are the perfect choice for garden rooms, conservatories and multi-folding doors; unobtrusive they do not interfere with the operation and may be colour coordinated to provide a seamless elegant finish. In sensitive areas such as computer and research laboratories, intensive care wards, classrooms and public areas including reception, bars and restaurants; IN2GLASS blinds are a flexible and energy efficient response to managing a building's environment.

Why IN2GLASS?

- Sealed within the glazed unit, oblivious to dust, moisture and abuse
- Provides a discrete privacy barrier and a reduction in sound and solar gain
- Easy to operate, fully controllable by a simple sliding magnet, no cords
- Suitable for residential, commercial, educational and medical buildings
- Choice of 14 aluminium colours and 17 different fabrics
- Tested to EN 1279
- Stylish and safe solution
- Improves energy ratings
- Maintenance free
- Durable